

ÖLÇEK
1/1

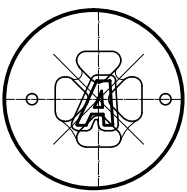

ALKALSAN
ALÜMİNYUM KALIPLARI
SAN.VE TİC. LTD. ŞTİ.

Tel : +90 216 378 18 08-10-11 (PBX)
Fax : +90 216 378 31 33
E-mail : alkalsan@alkalsan.com
Web : www.alkalsan.com

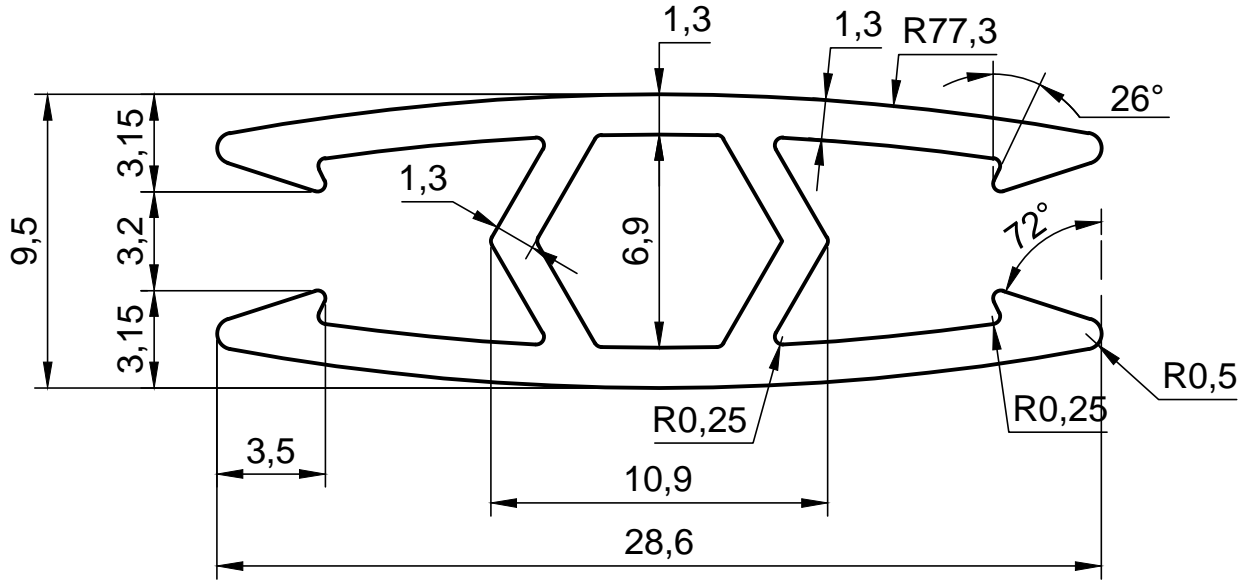

DIN EN ISO 9001:2000
Zertifikat: 01 100 044405

Tolerans : Tolerance :	DIN 1748	TARİH DATE	15.05.2008
ALKALSAN NO :	A19954	ÇİZEN NAME	HATİCE ERKAN
MÜŞTERİ CUSTOMER :	NEVSAN	KONTROL CONTROL	SERDAR KILIÇ
MÜŞTERİ NO : CUSTOMER NO :		ÖLÇEK SCALE	3/1
PRES PRESS :	1400 TON	ÇEVRE PERIMETER (mm)	145.8
KOVAN CONTAINER :	Ø145	ALAN AREA (mm ²)	99.2
		AĞIRLIK WEIGHT (gr/m)	268.8