

ÖLÇEK
1/1

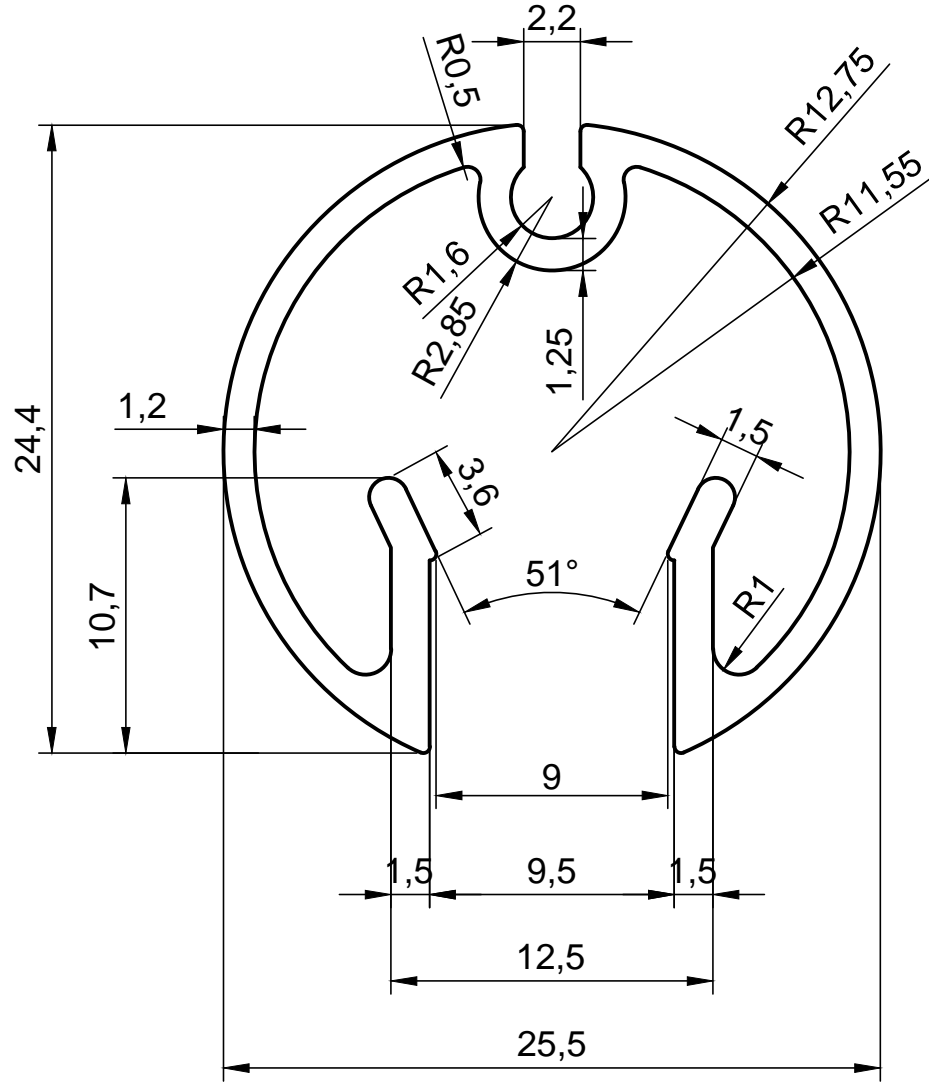

ELOKSALLI OLARAK YAPILACAKTIR..



ALKALSAN
ALÜMİNYUM KALIPLARI
SAN.VE TİC. LTD. ŞTİ.

Tel : +90 216 378 18 08-10-11 (PBX)
Fax : +90 216 378 31 33
E-mail : alkalsan@alkalsan.com
Web : www.alkalsan.com



DIN EN ISO 9001:2000
Zertifikat: 01 100 044405

Tolerans : Tolerance :	EN 755 - 9	TARİH DATE	28.01.2009
ALKALSAN NO :	A21599	ÇİZEN NAME	HANİFE SANCAR
MÜŞTERİ CUSTOMER :	NEVSAN	KONTROL CONTROL	OĞUZHAN BAYRAM
MÜŞTERİ NO : CUSTOMER NO :		ÖLÇEK SCALE	2.5/1
PRES PRESS :	1250 TON	ÇEVRE PERIMETER (mm)	181.1
KOVAN CONTAINER :	Ø155	ALAN AREA (mm ²)	120.1
		AĞIRLIK WEIGHT (gr/m)	325.5